



the FLS extender

english



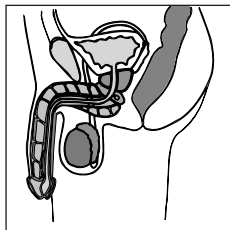
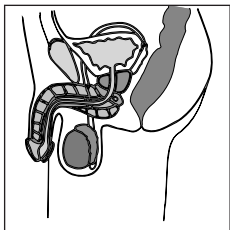

TABLE OF CONTENTS

4 - 5	INTRODUCTION
6 - 7	DESCRIPTION OF THE VARIOUS COMPONENTS AND INSTRUCTIONS FOR ASSEMBLAGE
8 - 9	INSTRUCTIONS FOR MOUNTING
10 - 11	INSTRUCTIONS FOR ADJUSTMENT
12	INSTRUCTIONS FOR USE AND DISMOUNTING OF JES-EXTENDER PROBLEM SOLVING
14 - 15	MATERIALS USED
16	THE VARIOUS COMPONENTS OF THE Jes-Extender
17	CLEANING
18	WORLDWIDE WARRANTY
19	ENVIRONMENTAL ASPECTS
20	PERSONAL NOTES

SEE ALSO OUR WEBSITE <WWW.JES-EXTENDER.COM> FOR MORE INFORMATION

INTRODUCTION

The Jes-Extender was designed and developed in Denmark by the medical specialist Jørn Ege Siana. The purpose of the Jes-Extender is to enlarge the penis by means of traction. The Jes-Extender can be used either as a supplement to surgical penile lengthening or as a gentle mono-therapeutic device. The use of the Jes-Extender does not require medical supervision.

The mechanism of the device is based on the principle of traction, a method which simulates the human body's natural reaction to the application of physical force. Tissue cells react by multiplying and the tissue gradually expands, both in length and width, a principle utilized by various indigenous tribes for multiple doubling of the size of earlobes and lips.

The Jes-Extender has been tested on patients who have all obtained enlargement of the penis after using the device in accordance with instructions. The enlargement is permanent and does not entail a narrowing of the circumference of the penis.

The test subjects achieved an average lengthening of the erected penis of 2.8 cm (24 per cent) after a treatment period of 3-4 months. The treatment does not affect urination, sexual pleasure or the power of reproduction. Enlargement can only be obtained by daily usage of the device and the effect correlates with the number of hours of usage. The above mentioned results were obtained after 12 hours' daily treatment over a period of 3 months.

The Jes-Extender can be used throughout the day for various periods of time. It is not necessary to wear the Jes-Extender for a long uninterrupted time to obtain results. As an example: 2 hours daily treatment for 12 months, will give the same final result as 12 hours daily for 2 months. You can also take a break for a period of time, without diminishing the final result. Refraining from using the Jes-Extender does not result in “loosing” part of the enlargement already gained. It may also be worn at night but may become detached during uneasy sleep or during a nightly erection. It is recommended to use the Protection Pad or other protective measure when the Jes-Extender is worn at night. Accidental detachment is quite harmless and merely requires re-mounting of the device. During the daytime the device may be worn under a pair of loose-fitting trousers.

WARNING: The following precautions must be observed: The device must not be worn during bowel movements, during sports activities, during intercourse or other strenuous physical activity. Neither should it be worn after consumption of alcohol or ingestion of pain-killers or euphorants or if there are any wounds or infected areas on the penis. If pain, numbness or bluish discoloration of the penis head, or any other untoward reaction occurs the device must be loosened and removed immediately. In case of wounds on the penis the device must not be worn until these have healed entirely.

Finally, the device should not be worn while moving in areas where there is an increased risk of falling and caution must be exercised when climbing stairs, walking on slippery floors etc. The device should not be worn neither when handling any kind of machinery, motorized vehicles or hot objects nor when bicyckling or cooking.

DESCRIPTION OF THE VARIOUS COMPONENTS AND INSTRUCTION FOR ASSEMBLAGE

The Jes-Extender consists of a basal plastic ring (1) with a recess for the urethra (2). The ring is fastened around the root of the penis. Two metal bars, one with a right-handed thread (3), the other with a left-handed thread (4) are attached to the basal ring. Inside each bar, hidden in a tube, is a spring contrivance (5). At the distal end the two bars are attached to a plastic support (6) with two holes, through which the ends of a silicone tube are passed.

The components 1-5 are preassembled on delivery and should never be disassembled beyond this point. Depending on the size of the penis either the short or the long extension bars are mounted. The additional extension bars are required for later usage as lengthening of the penis occurs. The plastic support is mounted by introducing the ends of the bars (5) into the two big holes of the support. The support is then pressed towards the basal ring (1). The springs are thus pressed home. Pressure should be exerted until a snap or a click indicates that the support is firmly secured to the bars.

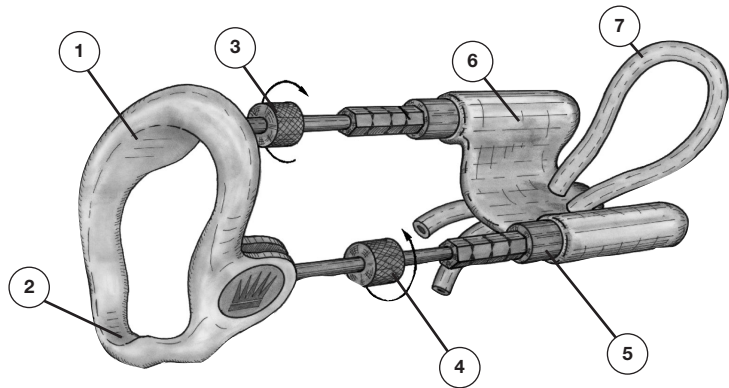

Fig 1

INSTRUCTIONS FOR MOUNTING

The device is mounted by fastening the basal ring (1) around the root of the penis, so that the two metal bars (2) run parallel with the penis, one on each side, and the head of the penis rests in the bowl-shaped support (3). By passing the two ends of the silicone tube through the holes in the plastic support (4) a loop is made through which the head of the penis is introduced. Before fastening of the penis the plastic support should be pressed towards the body so that the two springs press home. The silicone tube is fastened around the penis head by pulling the ends of the tube (5) on the reverse side of the support. The ends are pressed into the two notches (6) to secure the fastening of the penis head. Additional pieces of metal bar (7) may be added as required.

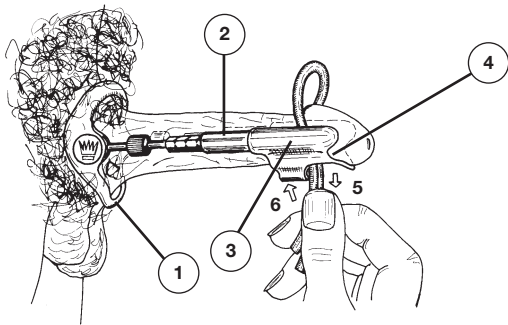

Fig 2

PROTECTION PAD ACCESSORY TO THE JES-EXTENDER.

In rare cases initial soreness can be experienced from using the Jes-Extender. Such soreness is usually caused by initial excess of force, which should not exceed 900 gram of traction for 4-8 hours daily during the first 2-3 weeks. The force of the traction should then be increased to 900-1200 grams, and the treatment period to 6-12 hours daily.

To relieve such occasional soreness, the enclosed Protection Pad can be used in the following way:

- Expand the Protection Pad slowly.
- Fit it behind the penis glans, and allow it to contract to a snug fit.
- Mount the extra long silicone tube as usual.

The Protection Pad can be washed in lukewarm water, and new pads can be purchased at your local Jes-Extender dealer.

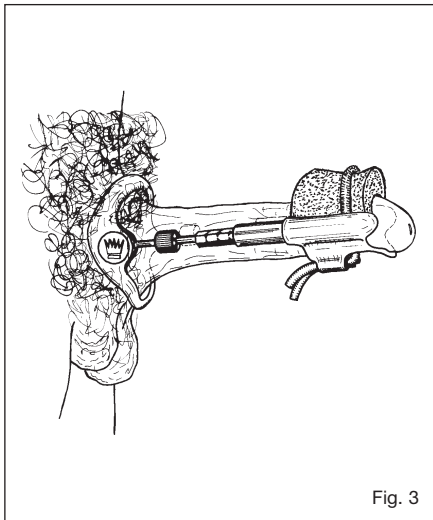

Fig. 3

INSTRUCTIONS FOR ADJUSTMENT

When the device has been fitted the force of traction can be adjusted by turning the two thumb-screws (1) in an inward direction. The actual force exerted can be read on the hexagonal pistons (2) and the force of traction can be varied from 900 to 1200 or 1500 g (see fig. 4). Each marking on the piston equals a traction force of 300 g. Thus, at the exertion of maximum force (1500 g) only one marking is visible on the piston. A force of 900 g is recommended for the first 2-3 weeks and during that period the Extender should not be worn for more than 4-5 hours a day. From then on the force may be increased to 900-1200 g and to 6-12 hours daily usage of the device. You can continue to use the device for further months.

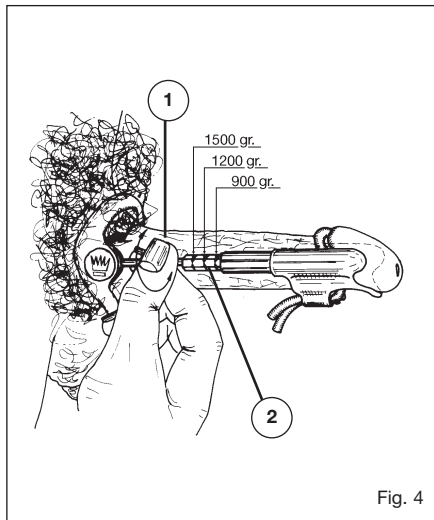

Fig. 4

INSTRUCTIONS FOR USE AND DISMOUNTING OF THE JES-EXTENDER

During use of the Jes-Extender the penis can be held at any position except sideways. In a pair of loose-fitting trousers the device is inconspicuous. It can be worn at night but may become detached during uneasy sleep or during a nightly erection. Accidental detachment merely requires re-mounting of the device. The device is dismounted by loosening the silicone tube from the ventral side of the support. The Jes-Extender can then be detached. The thumbscrews are screwed home in an outward direction towards the basal ring. When not in use the Jes-Extender can be left assembled or it can be disassembled and placed in the box as required.

PROBLEM SOLVING

Problem: No reading of the traction force on the hexagonal piston

Solution: a) Make sure you are using the longest sidebars, allowed by your current flaccid penis length.

b) Push the plastic front piece toward yourself, making the springs press home, before fixating the glans with the silicone band.

c) Make sure to leave 1mm space between the thumbscrews and both the plastic ring and the hexagonal pistons, before expanding the length on both sides of the screw by turning the screws inward.

Caution: Do not continue turning the thumbscrews inward, when the screw has expanded to the maximum (thread becomes visible in the ends). This will cause the Jes-Extender to disassemble!

Problem: The glans slips out from underneath the silicone tube.

Solution: Tighten the silicone tube. If this causes circulation problems and discomfort in the glans, use the Protection Pad as described in the instructions manual, page 10. If this doesn't solve the problem entirely, get some: "Riklastic", "cohesive elastic securing bandage".

Measurements: 6cm/2,5 m. Wrap the bandage around the back of the glans, and combine with the Protection Pad, before the silicone tube is fastened on top of both the Protection Pad and the bandage. Discomfort/circulation problems can also be avoided by taking a 5 min.

break every 1-2 hours. These breaks do not affect the final result. Other options to solve circulation problems are a "Soft Attach" or "Comfort Strap". Please contact your local dealer for details. Securing Bandage can also be ordered at your local dealer, or bought at your local drug-store.

Problem: The silicone tube slips out of the notches!

Solution: This is usually caused by washing the tube frequently in warm water. Get new tubes from your local dealer.

Fig. 5

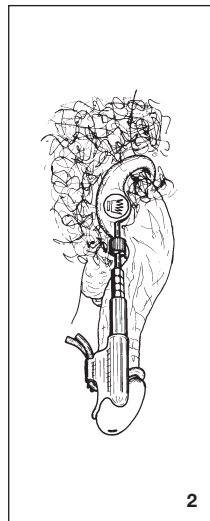
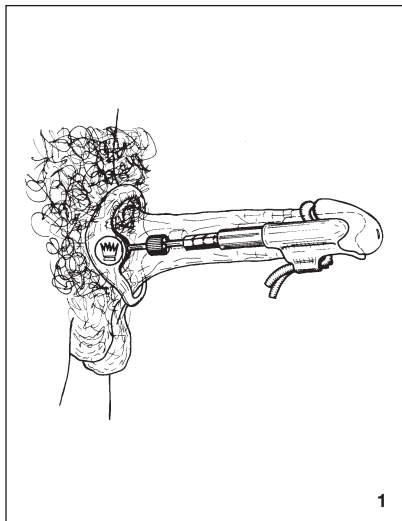

MATERIALS USED

- 1 Silicone type: WMQ, USP 21-4, PA/HP/exp3/(82)57/1984.
Owing to its chemical composition Silicone rubber is temperature resistant, weather resistant and resistant to wear and tear. It is proof against exposure to temperatures ranging from -65°C to $+210^{\circ}\text{C}$.
- 2 + 4 Plastic parts: POM (Hostaform), C 2521 G
Proof against temperatures ranging from -20°C to $+80^{\circ}\text{C}$.
- 3 Brass: CuZnS9Pb3 - W.no. 2.0401.

Nitin coating: Nitin is an intermetallic composition, combining the properties of nickel and tin, which is produced by electrolytic depositing. Clinical trials have demonstrated that Nitin coatings, despite their contents of 35% nickel, do not seem to precipitate any reaction in nickel allergists.
- 5 Stainless steel springs: Din 17224 - W.no. 4310

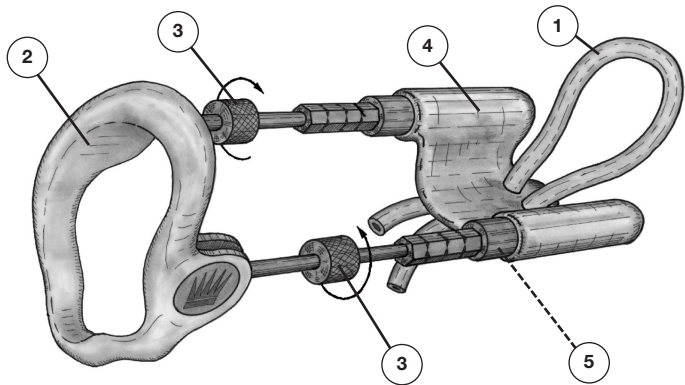

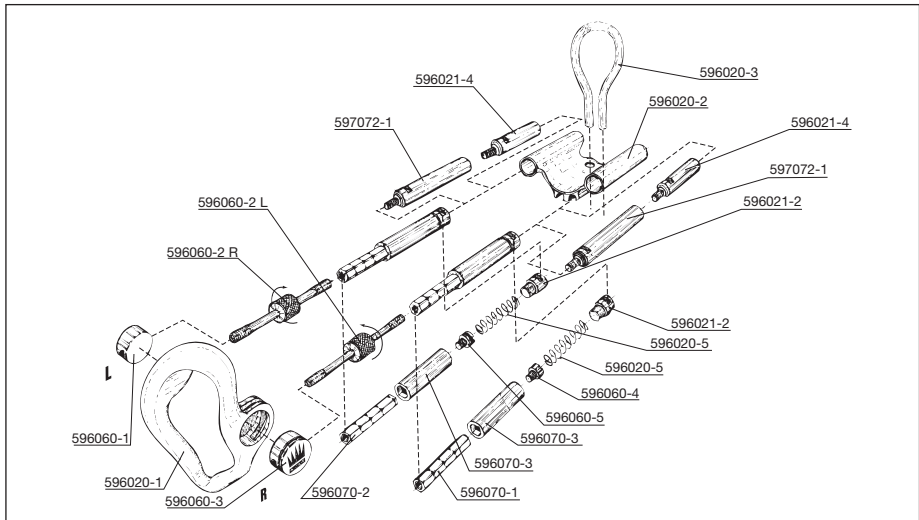

CLEANING

The Jes-Extender should be cleaned daily with toilet soap and water.
A chlorhexidine alcohol solution of 0.5% can be used for disinfection.



WORLDWIDE WARRANTY

Your Jes-Extender is covered by warranty for a period of 24 months under the following conditions: The warranty covers claims which result from defects in material or workmanship. If a defect is discovered the Jes-Extender must be returned to the dealer together with the completed warranty card.

WARRANTY CARD

Date of purchase: _____

Dealer: _____

Phone no.: _____

Address: _____

ENVIROMENTAL ASPECTS

The Jes-Extender is delivered in packaging indispensable to shipment of the device. Only environment friendly and recycable materials are used.

Glue and varnish: Water based.

Corrugated paper: Contains no less than 45% recycled material.

Plastic bags: PVC-free. Only carbon dioxide and water are liberated on incineration.

The brochure: The paper is made of chlorine free bleached cellulose.
Printing ink does not contain heavy metals.

Foam rubber: Made of PUR foam. Does not emit agents which act on the skin.

PERSONAL NOTES

Table to note the daily usage of the Jes-Extender.

	1	2	3	4	5	6	7	8	9	10	11	12	13	14	15	16	17	18	19	20	21	22	23	24	25	26	27	28	29	30	31
Month 1																															
Month 2																															
Month 3																															
Month 4																															
Month 5																															